

BARdolino Walllight 2.0

VOUTENPROFIL | COVE PROFILE

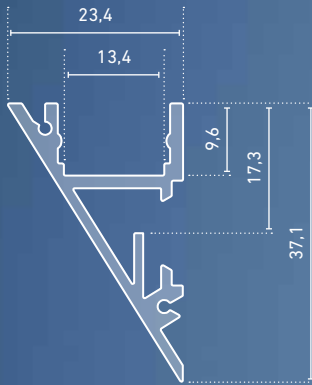

- » hochwertiges Design-Voutenprofil aus Aluminium, eloxiert
- » mit integrierter Kabelführung
- » ideal geeignet zur indirekten Beleuchtung ohne bauseits vorhandene Voute
- » wahlweise nach oben, unten oder seitlich (z.B. an Kanten) abstrahlend
- » RAL-Pulverbeschichtung auf Anfrage

- » high quality aluminium design cove profile, anodised
- » with integrated cable duct
- » ideally suited for indirect lighting without an existing cove on site
- » light emission either upwards, downwards or sideways (e.g. at edges) possible
- » RAL powder coating on request

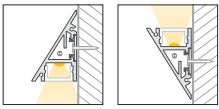

BARdolino Walllight 2.0

ABMESSUNGEN: 23,4 x 37,1 mm | DIMENSIONS: 23.4 x 37.1 mm



Artikel-Nr. Item no.	Länge Length
62398401	1.000 mm
62398402	2.010 mm
62398403	3.020 mm*
62398405	5.030 mm*





Bestellen Sie Ihr Aluminiumprofil/Kunststoffabdeckung auf Wunschlänge | Order your aluminum profile/plastic diffuser in desired length
62397000 Zuschnitt Aluminiumprofil oder Kunststoffabdeckung, je Schnitt | cut to size aluminum profile or plastic diffuser, per cut

ABDECKUNGEN | DIFFUSER

ABMESSUNGEN: 14,8 x 8 mm | DIMENSIONS: 14.8 x 8 mm

Artikel-Nr. Item no.	Beschreibung Description	
6239930#	Abdeckung opalweiß, PMMA, für eine homogene und blendfreie Lichtverteilung diffuser opal white, PMMA, for a homogenous and glare-free light distribution	
6239937#	Abdeckung satiniert, PMMA, für eine diffuse Lichtverteilung bei gleichzeitigem Verbergen der Technik diffuser satined, PMMA, for a diffused light distribution and concealment of the technology	
6239940#	Abdeckung klar, PMMA, für eine maximale Lichtausbeute bei gleichzeitigem Schutz der Technik diffuser clear, PMMA, for maximum light yield and protection of the LED strip	

ABMESSUNGEN: 14,8 x 11 mm | DIMENSIONS: 14.8 x 11 mm

6239933#	Abdeckung klar, PMMA, 30°-Linse für eine gerichtete Lichtbündelung diffuser clear, PMMA, 30° lens for a directed light focus	
6239934#	Abdeckung satiniert, PMMA, 30°-Linse für eine gerichtete Lichtbündelung diffuser satined, PMMA, 30° lens for a directed light focus	

Bitte ersetzen Sie in der Artikel-Nr. # durch die gewünschte Länge |
please replace the # in the item number with the required length
Länge | length: #=1: 1 m #=2: 2,01 m #=3: 3,02 m #=5: 5,03 m

ENDKAPPEN | END CAPS

Artikel-Nr. Item no.	Beschreibung Description	
62399917	Endkappen-Set (links/rechts), Aluminium, eloxiert, Stärke: 1,5 mm, 2 Stück inkl. 4 Schrauben end cap set (left/right), aluminium, anodised, thickness: 1.5 mm, 2 pieces incl. screws	

ZUBEHÖR | ACCESSORIES

Artikel-Nr. Item no.	Beschreibung Description	
62399914	Halter-Set, Kunststoff, Abmessungen: 34 x 13 x 5 mm, 2 Stück, inkl. 4 Schrauben bracket set, plastic, dimensions: 34 x 13 x 5 mm, 2 pieces, incl. 4 screws	
62399916	Halter-Set für Betonwände, Kunststoff, Abmessungen: 34 x 13 x 5 mm, 2 Stück, inkl. 4 Schrauben und Dübel bracket set for concrete walls, plastic, dimensions: 34 x 13 x 5 mm, 2 pieces, incl. 4 screws and dowels	
62399906	Halter-Set, V2A-Edelstahl, 2 Stück, inkl. 2 Schrauben bracket set, 304 stainless steel, 2 pieces, incl. 2 screws	